



TL1250 family 4K Resolution Day/Night lenses for 1/1.7" sensors

- ✓ **Ultra high resolution for 4K cameras**, up to 12.4 megapixel
- ✓ Available in DC **autoiris**, **P-iris**, and **manual iris** versions
- ✓ **Fully motorized versions**, or combinations with zoom, focus, iris, IR cut, limit switch; non-motorized versions also available
- ✓ IR corrected for true **Day/Night** cameras
- ✓ **Compact design** to fit into domes as small as 4" mini-dome size
- ✓ **CS-mount** and smooth **D25 board mount** options
- ✓ Used for sensor sizes 1/2.5", 1/2.3", 1/2" 1/1.8", and **up to 1/1.7"** (Sony IMX178, Sony IMX226 for example)

TL1250 lens family specifications

Focal length	12-50mm
Image circle	Up to Ø9.4mm
Resolution	12.4 megapixel
F/#	F/1.8 @ 12mm - F/2.4 @ 50mm to close
IR Correction	Day/Night
Focus Range	2.0m - infinity
Lens length	< 64mm TTL
Back focal length	BFL 8.2mm (in air)
CRA	< 7°
Distortion	< 10% at 12mm, < 2% at 50mm
Relative illumination	>40%
Lens transmission	>80%
Weight	TBD
Operating temperature	-20C to 60C (<70% humidity, non-condensing)
Storage temperature	-30C to 70C (<90% humidity, non-condensing)

Field of view for sensor sizes

Sensor size	1/1.7"	1/1.8"	1/1.8" 4K*	1/2"	1/2.3"	1/2.5"
Horizontal	36° - 8.6°	36° - 8.6°	35° - 8.5°	30° - 7.4°	30° - 7.2°	27° - 6.7°
Vertical	26° - 6.5°	23° - 5.8°	17° - 4.3°	23° - 5.6°	22° - 5.5°	20° - 5.0°
Diagonal	46° - 11°	44° - 10°	40° - 9.5°	39° - 9.2°	38° - 9°	34° - 8.3°

*4K format = 4000 x 2000 pixels

Lens designation

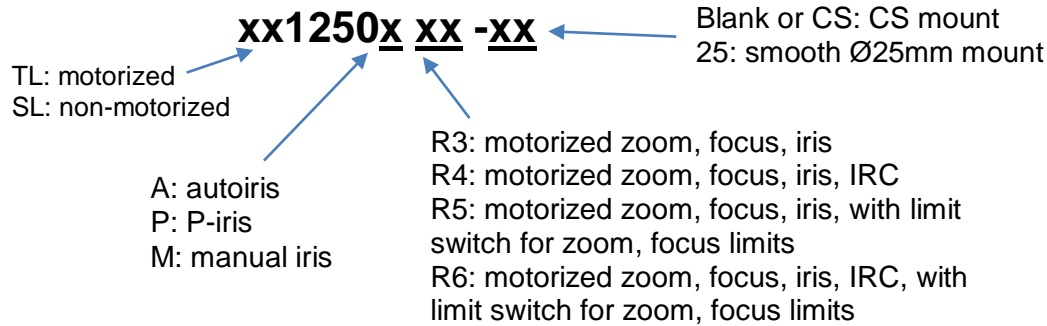

Production versions: (call for other versions)

SL1250M (manual lens, manual iris, CS mount)
 SL1250A (manual lens, DC autoiris, CS mount)
 SL1250P (manual lens, P-iris, CS mount)
 TL1250AR6-CS (fully motorized, DC autoiris lens)
 TL1250PR6-CS (fully motorized, P-iris lens)
 TL1250PR6-25 (fully motorized, P-iris lens, D25 mount)

Other versions are available by special request and may be added to regular production

TL1250 lens

(TL1250AR6 shown)

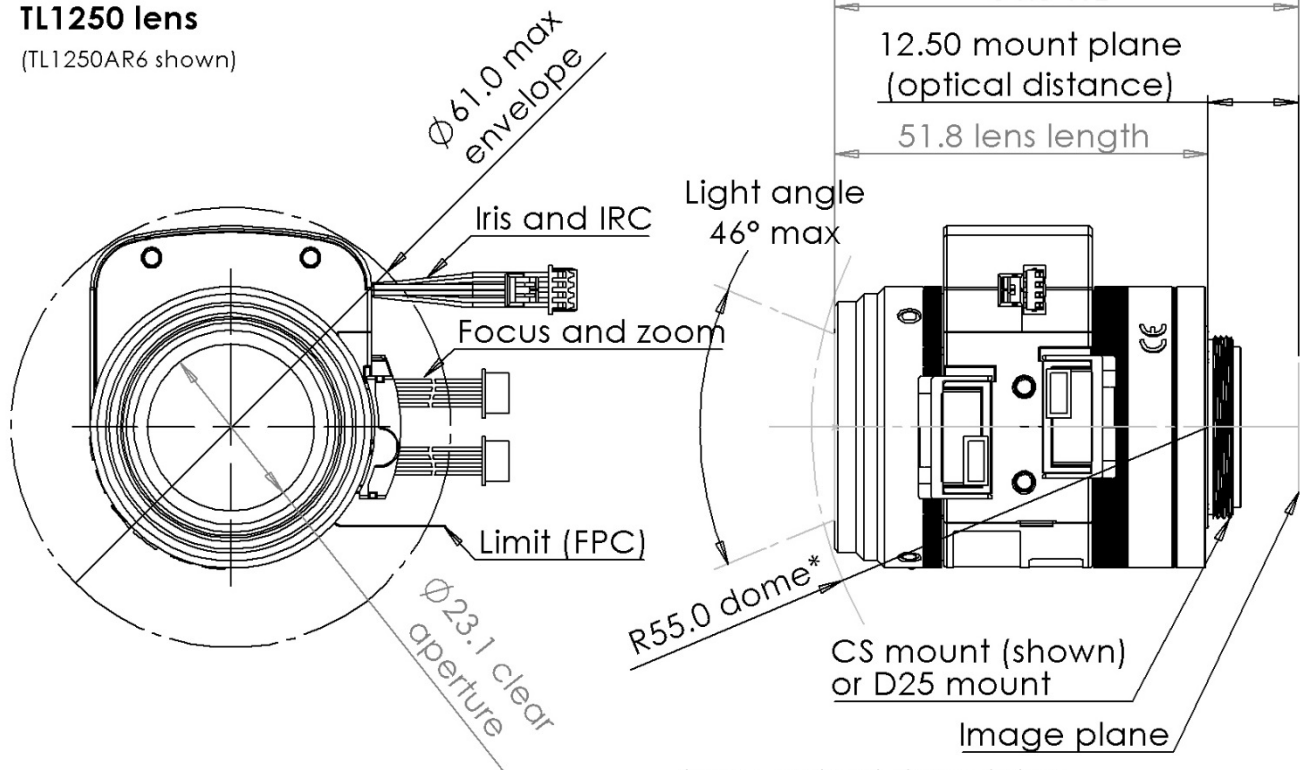

Theia Technologies
MDP 3/30/2015

Drawings of several of the versions of the TL1250 family.

Fully motorized (TL1250 -AR6, -PR6)

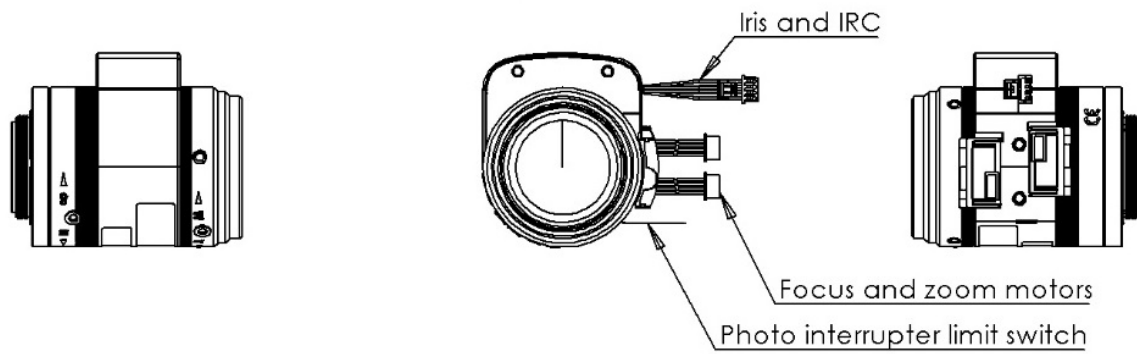

Autoiris/ P-iris (SL1250A, SL1250P)

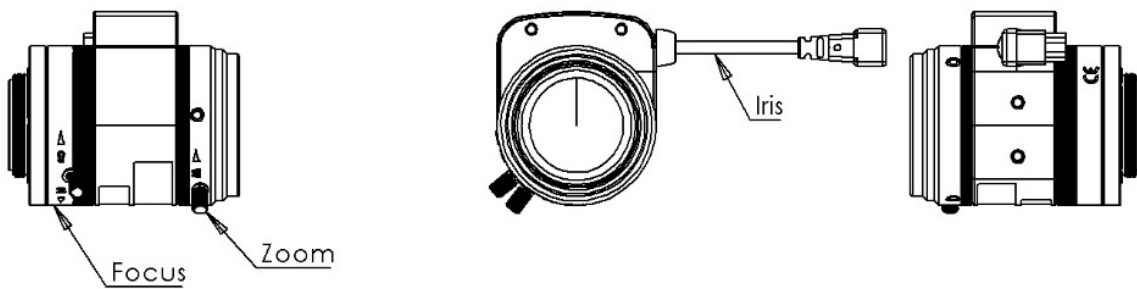

Manual version (SL1250M)

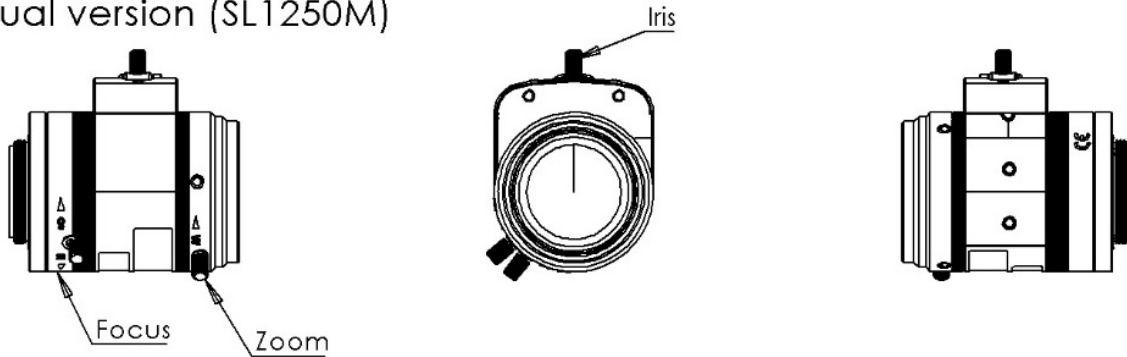

Zoom/Focus motor specifications

Drive	Stepper motor 2 phase bipolar drive			
Operation voltage	3.3V (operating range 2.6~4.8V)			
Maximum continuous operation time (seconds) for operation voltage and ambient temperature*		3.3V	4.0V	4.8V
	20C	60s	12s	6s
	40C	35s	9s	5s
	60C	20s	6s	4s
Coil resistance	28.5Ω (±7%)			
Gear ratio	1:1954			
Zoom speed	4 sec (@1000pps)			
Zoom cam rotation	75°			
Focus speed	8.9 sec (@600pps)			
Focus cam rotation	102°			
Focus/zoom connectors	Housing: Molex 51021-0800 Terminal: Molex 50058-8000			
Cable length	150mm			

Zoom: Wide -> Tele Focus: Near -> ∞				
Step	A+	A-	B+	B-
0	H	L	H	L
1	L	H	H	L
2	L	H	L	H
3	H	L	L	H

Pin	Color	Function	Motor
1	Brown	A+	Focus
2	Red	A-	Focus
3	Orange	B+	Focus
4	Yellow	B-	Focus
5	Brown	A+	Zoom
6	Red	A-	Zoom
7	Orange	B+	Zoom
8	Yellow	B-	Zoom

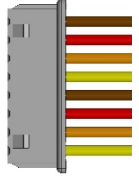

*Do not let motor temperature exceed 115°C

Zoom/Focus motor map for focus at infinity

Focal length [mm]	Zoom motor note	Zoom ring rotation [deg]	Zoom motor step number [#]	Focus ring rotation [deg]	Focus motor step number [#]
	Mechanical stop	0	0	187.50	8139
12.36	Wide end	0	0	117.58	5104
	PI trigger	2.5	109		
14.83		12.00	521	138.38	6007
18.05		24.00	1042	156.09	6776
22.28		36.00	1563	166.80	7241
27.86		48.00	2084	163.10	7080
35.20		60.00	2605	131.01	5687
	PI trigger			2.50	109
49.00	Tele end	75.00	3256	0.00	0
	Mechanical stop	75.00	3256	-7.50	-326

*PI: photo interrupter trigger point for applicable models TL1250*R5 and TL1250*R6

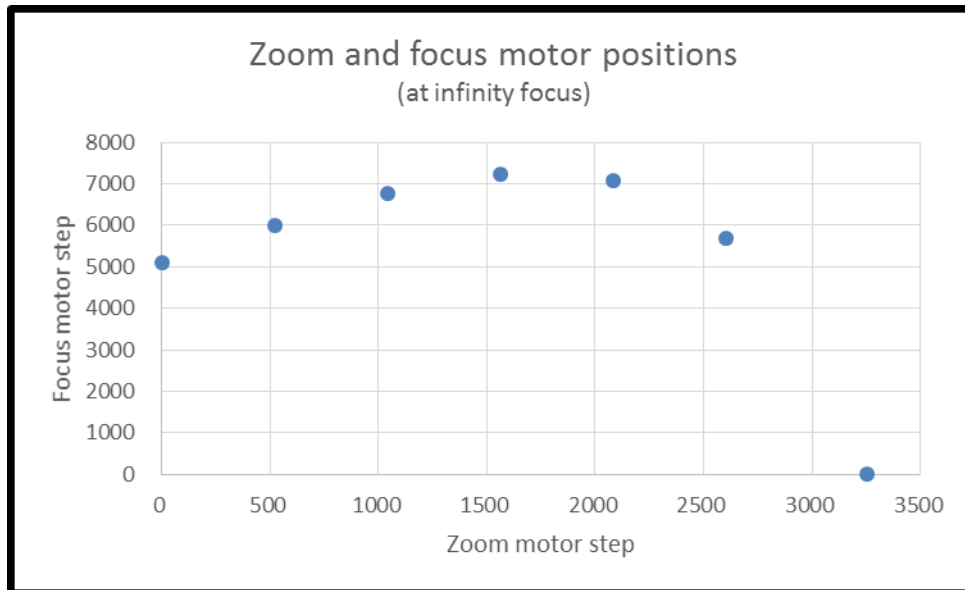

DC autoiris motor specifications

Applicable models: SL1250A, TL1250Axx

Drive	DC
Operation voltage	3V (2.5~5.0V)
Max current consumption	22mA
Drive coil resistance	190Ω
Damper coil resistance	855Ω

Connector type 1 (Molex)

Connector type	Housing: Molex 51021-0400 Terminal: Molex 50058-8000
Cable length	150mm

Pin	Color	Function
1	Brown	Control -
2	Red	Control +
3	Yellow	Drive +
4	Orange	Drive -

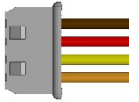

Connector type 2 (CCTV)

Connector type	Housing: EYC 221
Cable length	300mm

Pin	Function
1	Control -
2	Control +
3	Drive +
4	Drive -

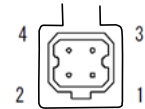

P-iris motor specifications

Applicable models: SL1250P, TL1250Pxx

Drive	Stepper motor 2 phase bipolar drive
Operating voltage	4V (+/-1)
Number of steps	75 (open to closed)
Basic step angle	18°
Maximum response freq.	1000pps
Coil resistance	30Ω

P-iris: open->close				
Step	A+	A-	B+	B-
0	H	L	H	L
1	L	H	H	L
2	L	H	L	H
3	H	L	L	H

Connector type 1 (Molex)

Connector type	Housing: Molex 51021-0400 Terminal: Molex 50058-8000
Cable length	150mm

Pin	Color	Function
1	Brown	B+
2	Red	B-
3	Yellow	A+
4	Orange	A-

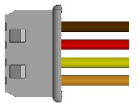

Connector type 2 (CCTV)

Connector type	Housing: EYC 221
Cable length	300mm

Pin	Function
1	B+
2	A+
3	A-
4	B-

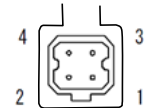

P-iris motor map

Step	Aperture Size [mm2]	F/#
1	95.0	1.84
5	90.8	1.88
10	82.1	1.98
15	72.8	2.10
20	63.4	2.25
25	54.0	2.43
30	44.9	2.67
35	36.0	2.98

Step	Aperture Size [mm2]	F/#
40	27.7	3.39
45	20.0	3.98
50	13.2	4.90
55	7.5	6.52
60	3.1	10.10
65	0.8	19.34
70	0.1	69.29
72	0.0	Closed
75	0.0	Closed

IR Cut specifications

Applicable models: TL1250AR4, TL1250PR4, TL1250AR6, TL1250PR6

Electrical specifications	
Drive	DC
Operating voltage	4.0V
Drive coil resistance	130Ω
Connector type	Housing: Molex 51021-0200 Terminal: Molex 50058-8000
Cable length	150mm
Optical specifications for IR filter (Day)	
Cut-on wavelength	405nm ±10nm
Visible transmission	430-610nm
Cut-off wavelength	650nm ±10nm
IR transmission	<5% max 700-1000nm <10% ave 1000-1100nm
Optical specifications for clear filter (Night)	
Visible transmission	400-1050nm

Mode	Pin 1	Pin 2
Day (IR filter)	L	H
Night (clear filter)	H	L
Wire color	Red	Black

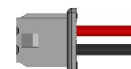

Zoom/Focus limit switch

Applicable models: TL1250AR5, TL1250PR5, TL1250AR6, TL1250PR6

Type	Photo interrupter phototransistor
Part model	Sharp GP1S396HCPSF
Operating voltage	3.3V
Output level	>2.2V HIGH <0.6V LOW
Connector type	FPC cable
Board-side mating connector type (not supplied)	Molex 52746-0671 Molex 52745-0697 Molex 52559-0652
Cable length	150mm

Pin*	Function	Motor
1	Cathode	Zoom
2	Anode/Collector	Zoom
3	Emitter	Zoom
4	Cathode	Focus
5	Anode/Collector	Focus
6	Emitter	Focus

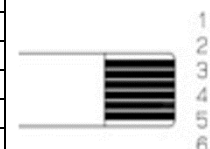

*cable side pin designation matches Molex 52746-0697 connector

Recommended circuit for each photo interrupter

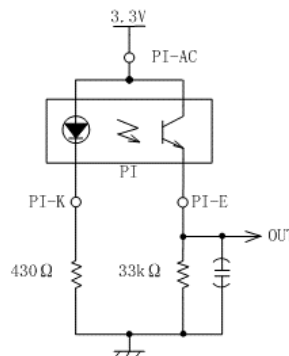

For more information contact

Theia Technologies
info@TheiaTech.com
www.TheiaTech.com

Revisions

Version	Change	Reason
160113	Added motor energizing time maximums	Clarification to prevent focus/zoom motor overheating
	Updated temperature spec	Consistent with motor supplier specification
	Changed minimum focus range to 2.0	Updated specification
	Changed p-iris steps to 75	Corrected from 72
	Updated IR filter transmission specs	